

PC410L0NIP

High Speed Response, High CMR OPIC Photocoupler

■ Features

1. High resistance to noise due to high common rejection voltage (CMR:MIN. 10kV/ μ s)
2. High speed response (t_{pLH} , t_{pHL} :MAX.75ns)
3. Isolation voltage between input and output ($V_{iso(rms)}$:3.75kV)
4. Mini-flat package

■ Applications

1. Programmable controllers
2. Inverters

■ Absolute Maximum Ratings ($T_a=25^\circ\text{C}$)

	Parameter	Symbol	Rating	Unit
Input	*1 Forward current	I_F	20	mA
	Reverse voltage	V_R	5	V
	Power dissipation	P	40	mW
Output	Supply voltage	V_{CC}	7	V
	High level output voltage	V_{OH}	7	V
	Low level output current	I_{OL}	50	mA
	*2 Collector power dissipation	P_C	85	mW
	*3 Isolation voltage	$V_{iso(rms)}$	3.75	kV
	Operating temperature	T_{opr}	-40 to +85	$^\circ\text{C}$
	Storage temperature	T_{stg}	-40 to +125	$^\circ\text{C}$
	*4 Soldering temperature	T_{sol}	270	$^\circ\text{C}$

*1 Refer to Fig.4

*2 Refer to Fig.5

*3 40 to 60%RH, AC for 1minute

*4 For 10s

■ Outline Dimensions

(Unit : mm)

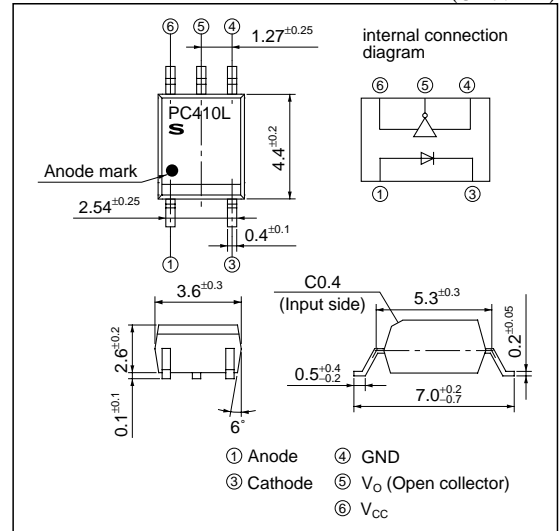

* "OPIC" (Optical IC) is a trademark of the SHARP Corporation.
An OPIC consists of a light-detecting element and signal-processing circuit integrated onto a single chip.

■ Electro-optical Characteristics

(Unless otherwise specified, $T_a = -40$ to 85°C)

Parameter		Symbol	Conditions		MIN.	TYP.	MAX.	Unit
Input	Forward voltage	V_F	$T_a = 25^\circ\text{C}$, $I_F = 10\text{mA}$		–	1.6	1.9	V
	Reverse current	I_R	$T_a = 25^\circ\text{C}$, $V_R = 5\text{V}$		–	–	10	μA
	Terminal capacitance	C_t	$T_a = 25^\circ\text{C}$, $V = 0$, $f = 1\text{MHz}$		–	60	150	pF
Output	Low level output voltage	V_{OL}	$I_{OL} = 13\text{mA}$, $V_{CC} = 5.5\text{V}$, $I_F = 5\text{mA}$		–	0.4	0.6	V
	High level output current	I_{OH}	$V_{CC} = V_O = 5.5\text{V}$, $I_F = 250\mu\text{A}$		–	0.02	100	μA
	Low level supply current	I_{CCL}	$V_{CC} = 5.5\text{V}$, $I_F = 10\text{mA}$		–	7	13	mA
	High level supply current	I_{CCH}	$V_{CC} = 5.5\text{V}$, $I_F = 0$		–	5	10	mA
	"High→Low" threshold input current	I_{FHL}	$V_{CC} = 5\text{V}$, $V_O = 0.8\text{V}$, $R_L = 350\Omega$		–	2.5	5	mA
	Isolation resistance	R_{ISO}	$T_a = 25^\circ\text{C}$, $\text{DC} = 500\text{V}$, 40 to 60% RH		5×10^{10}	1×10^{11}	–	Ω
Floating capacitance		C_f	$T_a = 25^\circ\text{C}$, $V = 0$, $f = 1\text{MHz}$		–	0.6	–	pF
Transfer characteristics	Response time	"High→Low" propagation delay time	t_{PHL}	$T_a = 25^\circ\text{C}$ $V_{CC} = 5\text{V}$, $I_F = 7.5\text{mA}$ $R_L = 350\Omega$, $C_L = 15\text{pF}$	25	48	75	ns
		"Low→High" propagation delay time	t_{PLH}		25	50	75	ns
		Rise time	t_r		–	10	–	ns
		Fall time	t_f		–	20	–	ns
		*5 Pulse width distortion	Δt_W		–	–	35	ns
	CMR	Instantaneous common mode rejection voltage "Output : High level"	CM_H		$I_F = 0$ $V_{O(\text{Min})} = 2\text{V}$	$T_a = 25^\circ\text{C}$ $V_{CC} = 5\text{V}$ $V_{CM} = 1\text{kV(P-P)}$ $R_L = 350\Omega$	10	20
Instantaneous common mode rejection voltage "Output : Low level"		CM_L	$I_F = 5\text{mA}$ $V_{O(\text{Max})} = 0.8\text{V}$	–10	–20		–	$\text{kV}/\mu\text{s}$

(Note) All typical values: at $T_a = 25^\circ\text{C}$, $V_{CC} = 5\text{V}$ *5 Pulse width distortion $\Delta t_W = |t_{PHL} - t_{PLH}|$

■ Recommended Operating Conditions

Parameter	Symbol	MIN.	MAX.	Unit
Low level input current	I_{FL}	0	250	μA
High level input current	I_{FH}	8	15	mA
Supply voltage	V_{CC}	4.5	5.5	V
Fanout (TTL load)	N	–	5	–
Operating temperature	T_{opr}	–40	+85	$^\circ\text{C}$

Connect a by-pass ceramic capacitor (0.01 to 0.1 μF) between V_{CC} and GND at the position within 1cm from lead pin

Fig.1 Block Diagram

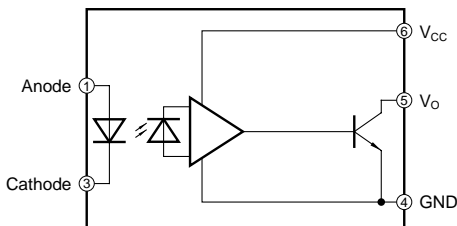

Fig.2 Test Circuit for t_{PHL} , t_{PLH} , t_r and t_f

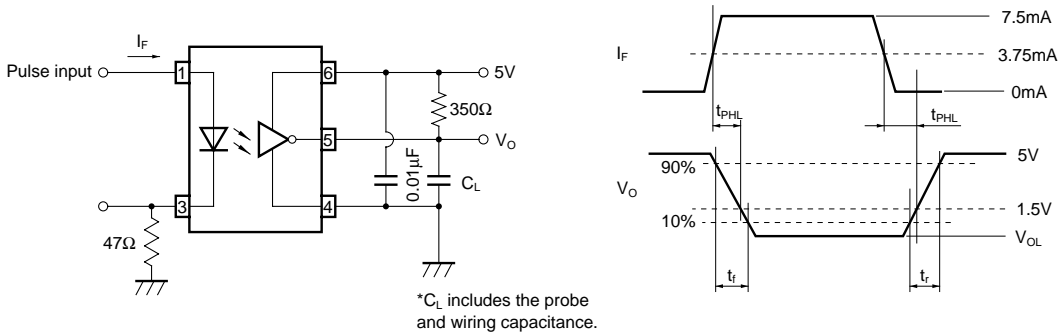

Fig.3 Test Circuit for Common Mode Rejection Voltage

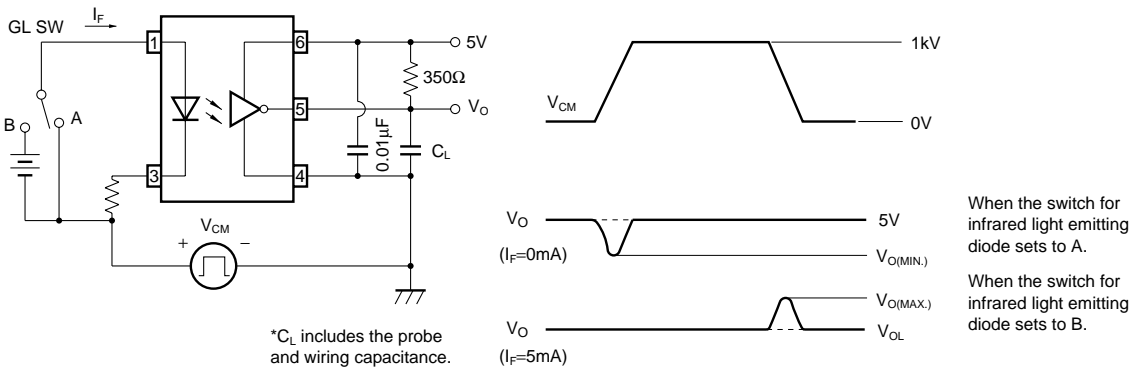

Fig.4 Forward Current vs. Ambient Temperature

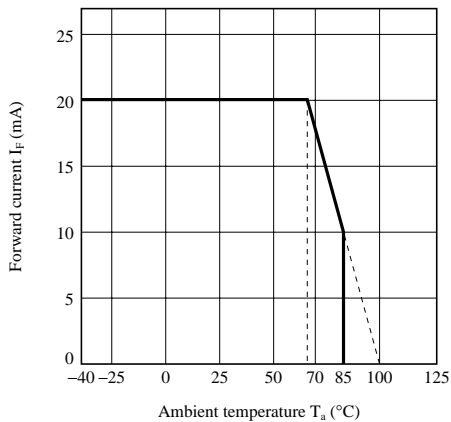

Fig.5 Collector Power Dissipation vs. Ambient Temperature

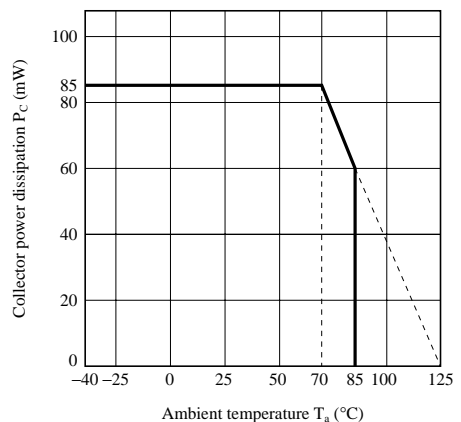

Fig.6 Forward Current vs. Forward Voltage

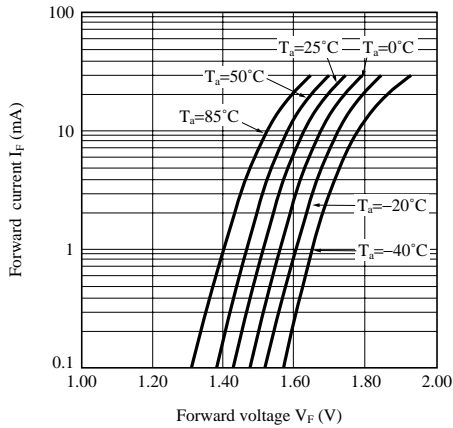

Fig.7 High Level Output Current vs. Ambient Temperature

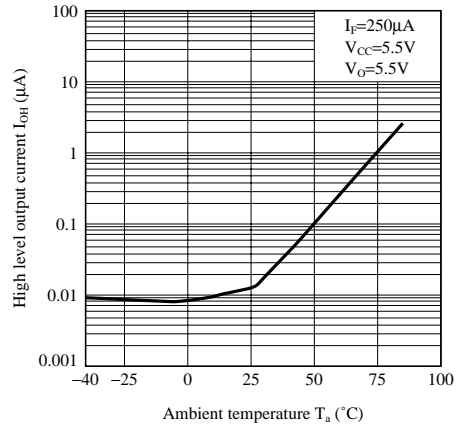

Fig.8 Low Level Output Voltage vs. Ambient Temperature

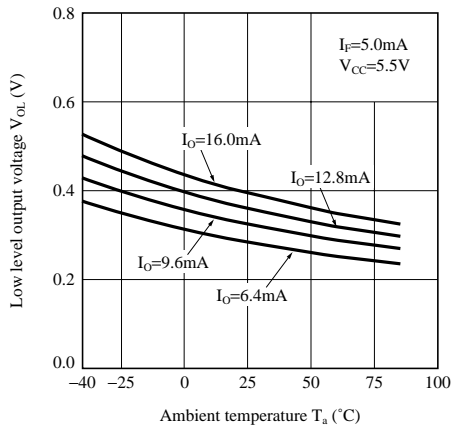

Fig.9 Output Voltage vs. Forward Current

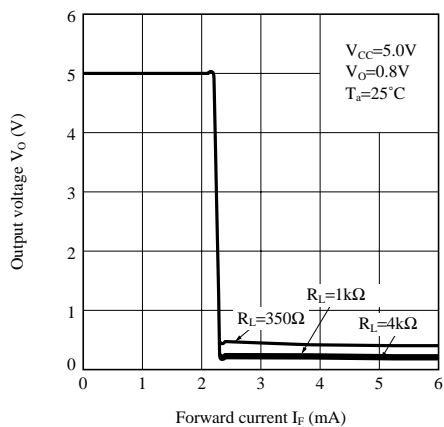

Fig.10 Threshold Input Current vs. Ambient Temperature

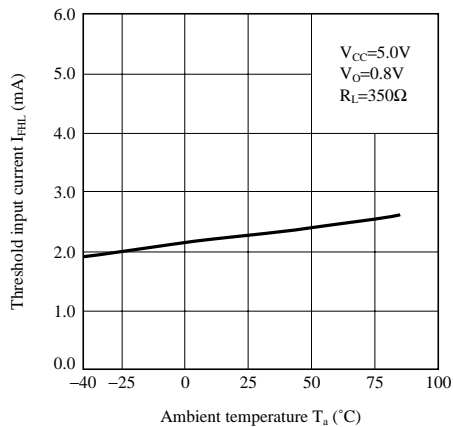

Fig.11 Propagation Delay Time vs. Forward Current

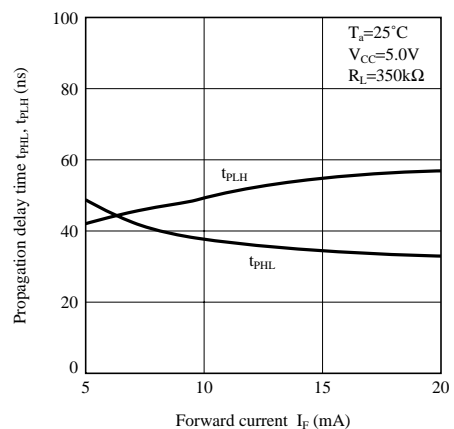
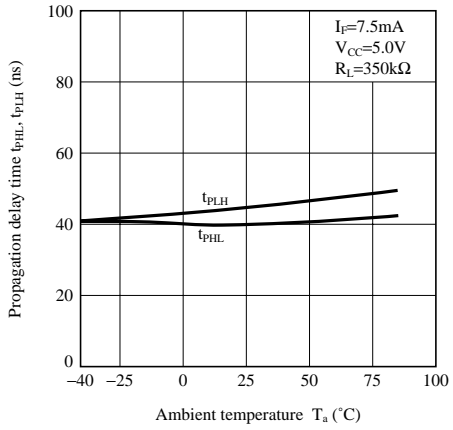

Fig.12 Propagation Delay Time vs. Ambient Temperature



NOTICE

- The circuit application examples in this publication are provided to explain representative applications of SHARP devices and are not intended to guarantee any circuit design or license any intellectual property rights. SHARP takes no responsibility for any problems related to any intellectual property right of a third party resulting from the use of SHARP's devices.
- Contact SHARP in order to obtain the latest device specification sheets before using any SHARP device. SHARP reserves the right to make changes in the specifications, characteristics, data, materials, structure, and other contents described herein at any time without notice in order to improve design or reliability. Manufacturing locations are also subject to change without notice.
- Observe the following points when using any devices in this publication. SHARP takes no responsibility for damage caused by improper use of the devices which does not meet the conditions and absolute maximum ratings to be used specified in the relevant specification sheet nor meet the following conditions:
 - (i) The devices in this publication are designed for use in general electronic equipment designs such as:
 - Personal computers
 - Office automation equipment
 - Telecommunication equipment [terminal]
 - Test and measurement equipment
 - Industrial control
 - Audio visual equipment
 - Consumer electronics
 - (ii) Measures such as fail-safe function and redundant design should be taken to ensure reliability and safety when SHARP devices are used for or in connection with equipment that requires higher reliability such as:
 - Transportation control and safety equipment (i.e., aircraft, trains, automobiles, etc.)
 - Traffic signals
 - Gas leakage sensor breakers
 - Alarm equipment
 - Various safety devices, etc.
 - (iii) SHARP devices shall not be used for or in connection with equipment that requires an extremely high level of reliability and safety such as:
 - Space applications
 - Telecommunication equipment [trunk lines]
 - Nuclear power control equipment
 - Medical and other life support equipment (e.g., scuba).
- If the SHARP devices listed in this publication fall within the scope of strategic products described in the Foreign Exchange and Foreign Trade Law of Japan, it is necessary to obtain approval to export such SHARP devices.
- This publication is the proprietary product of SHARP and is copyrighted, with all rights reserved. Under the copyright laws, no part of this publication may be reproduced or transmitted in any form or by any means, electronic or mechanical, for any purpose, in whole or in part, without the express written permission of SHARP. Express written permission is also required before any use of this publication may be made by a third party.
- Contact and consult with a SHARP representative if there are any questions about the contents of this publication.